

WEBINAR

19 Maggio 2022

NUOVA LINEA PRODOTTI IGIENICI LAUMAS



#LAUMASKNOWHOW



LAUMAS[®]
Innovation in Weighing



A COSA SERVE?

DESIGN IGIENICO

Ridurre al minimo il rischio di
contaminazione del prodotto

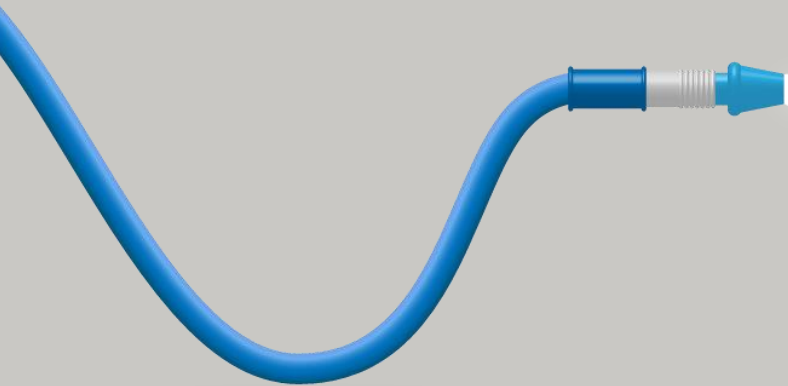

DESIGN IGIENICO

Settori



ALIMENTARE



BEVERAGE



FARMACEUTICA



CHIMICA



COSMETICA

DIRETTIVE INTERNAZIONALI

- LINEE GUIDA -



European Hygienic Engineering
and Design Group

EHEDG

FDA

Food and Drug Administration



3-A

3-A Sanitary Standards

COMPONENTI SANIFICABILI LAUMAS

REQUISITI IGIENICI

- ✓ Superfici lisce-levigate
- ✓ Spigoli raccordati
- ✓ Materiali resistenti alla corrosione
- ✓ Superfici accessibili (sanificabili)
- ✓ Guarnizioni certificate FDA

TEST DI PULIZIA



VANTAGGI DEL DESIGN IGIENICO

RISPARMIO TEMPO



VANTAGGI DEL DESIGN IGIENICO

RISPARMIO TEMPO

RISPARMIO ENERGIA



VANTAGGI DEL DESIGN IGIENICO

RISPARMIO TEMPO

RISPARMIO ENERGIA

RISPARMIO DETERGENTI



VANTAGGI DEL DESIGN IGIENICO

RISPARMIO TEMPO

RISPARMIO ENERGIA

RISPARMIO DETERGENTI

VANTAGGI PER L'AMBIENTE



COST

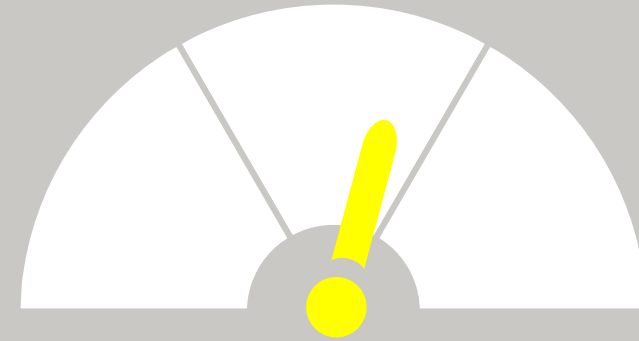

RISPARMIO SUI
COSTI DI PRODUZIONE



VANTAGGI ECONOMICI

COMPONENTI SANIFICABILI LAUMAS

Rispettano i requisiti igienici anche se **non vanno a contatto con il prodotto**



WINOX 3A



TLM81 3A



LCB 3A



FLC 3A



CDG 3A

CELLA DI CARICO PER PIEDINO

FLC 3A

Accessorio igienico RPSCQC certificato da 3-A SSI



CELLA DI CARICO PER PIEDINO

FLC 3A

Accessorio igienico RPSCQC certificato da 3-A SSI

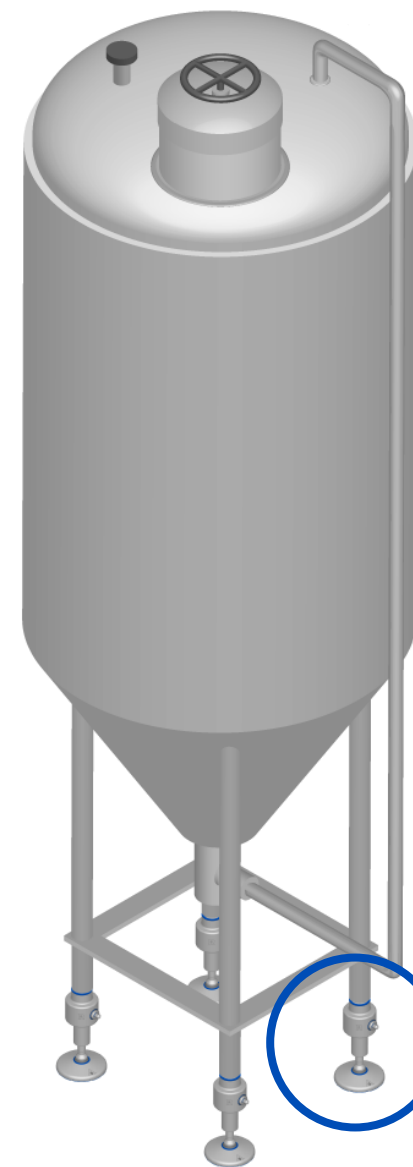

CELLA DI CARICO PER PIEDINO

FLC 3A

Accessorio igienico RPSCQC certificato da 3-A SSI

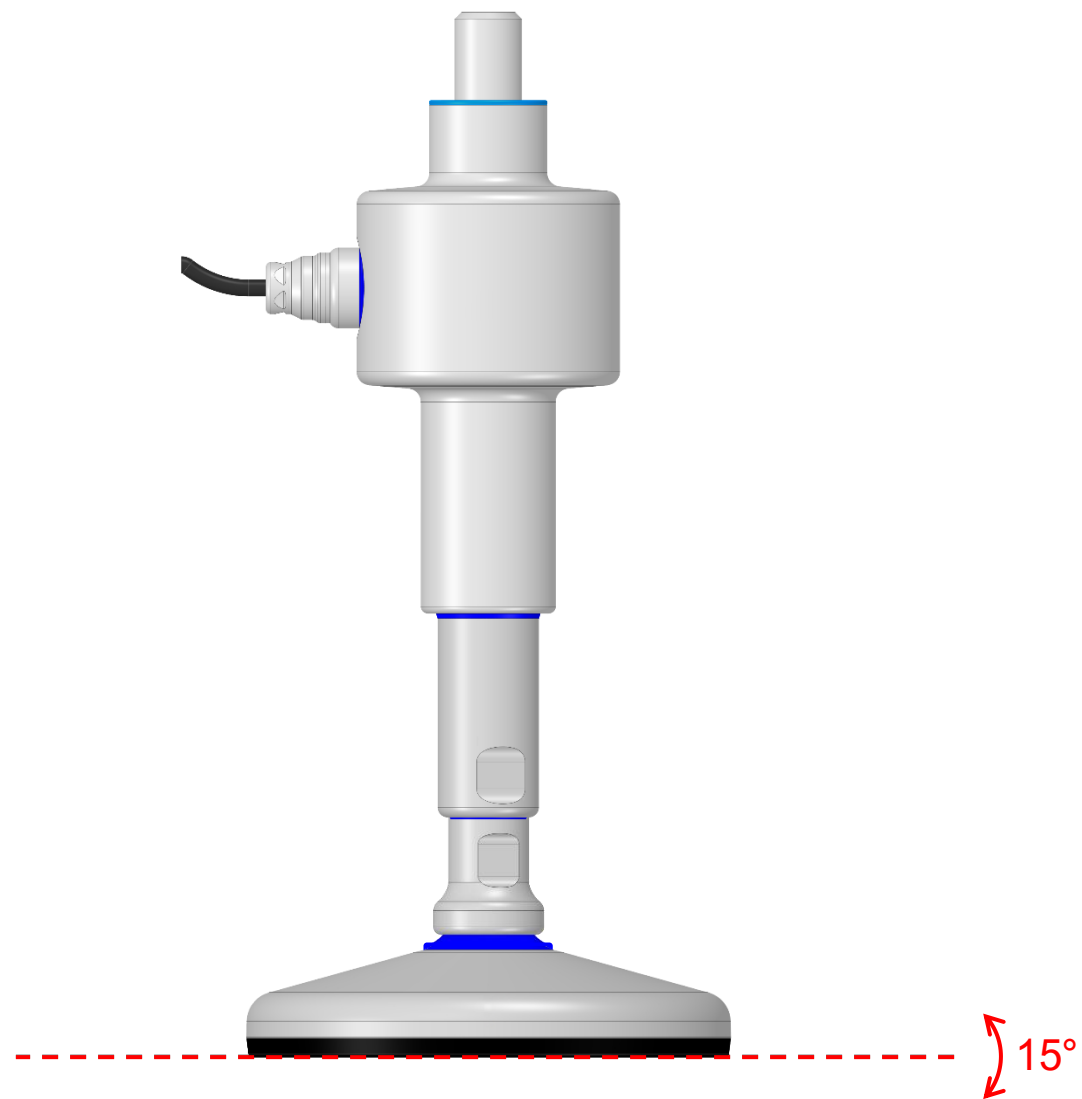

CELLA DI CARICO PER PIEDINO

FLC 3A

Accessorio igienico RPSCQC certificato da 3-A SSI

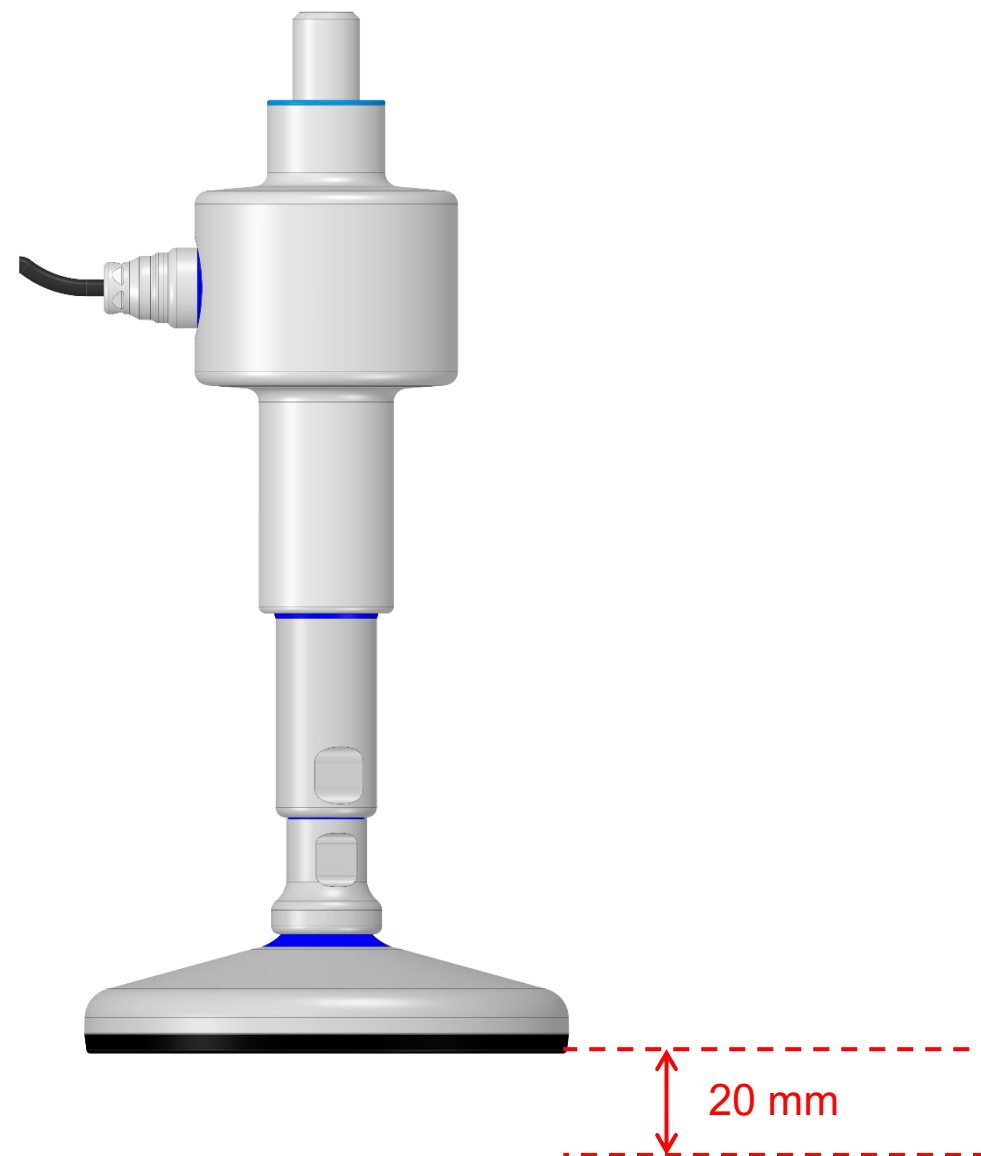

CELLA DI CARICO PER PIEDINO

FLC 3A

Accessorio igienico RPSCQC certificato da 3-A SSI

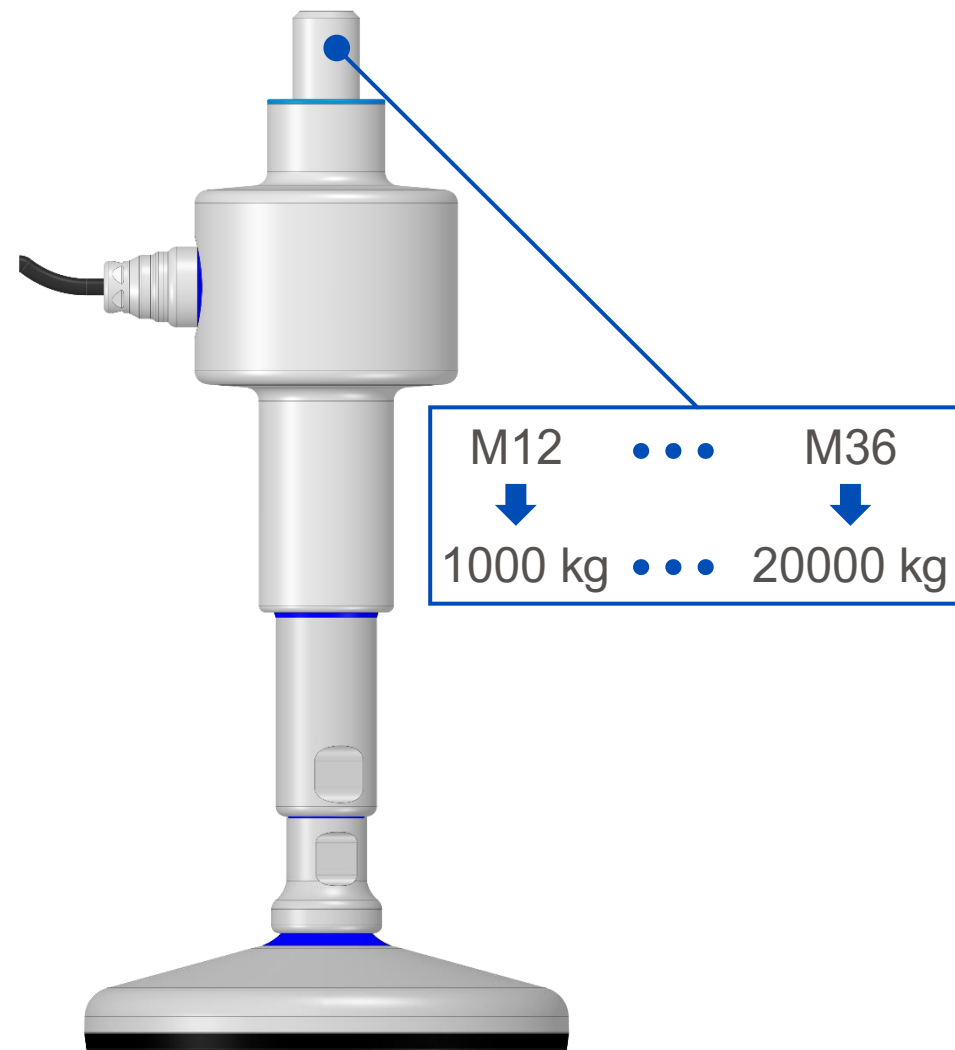

CELLA DI CARICO PER PIEDINO

FLC 3A

Accessorio igienico RPSCQC certificato da 3-A SSI



REQUISITI IGIENICI

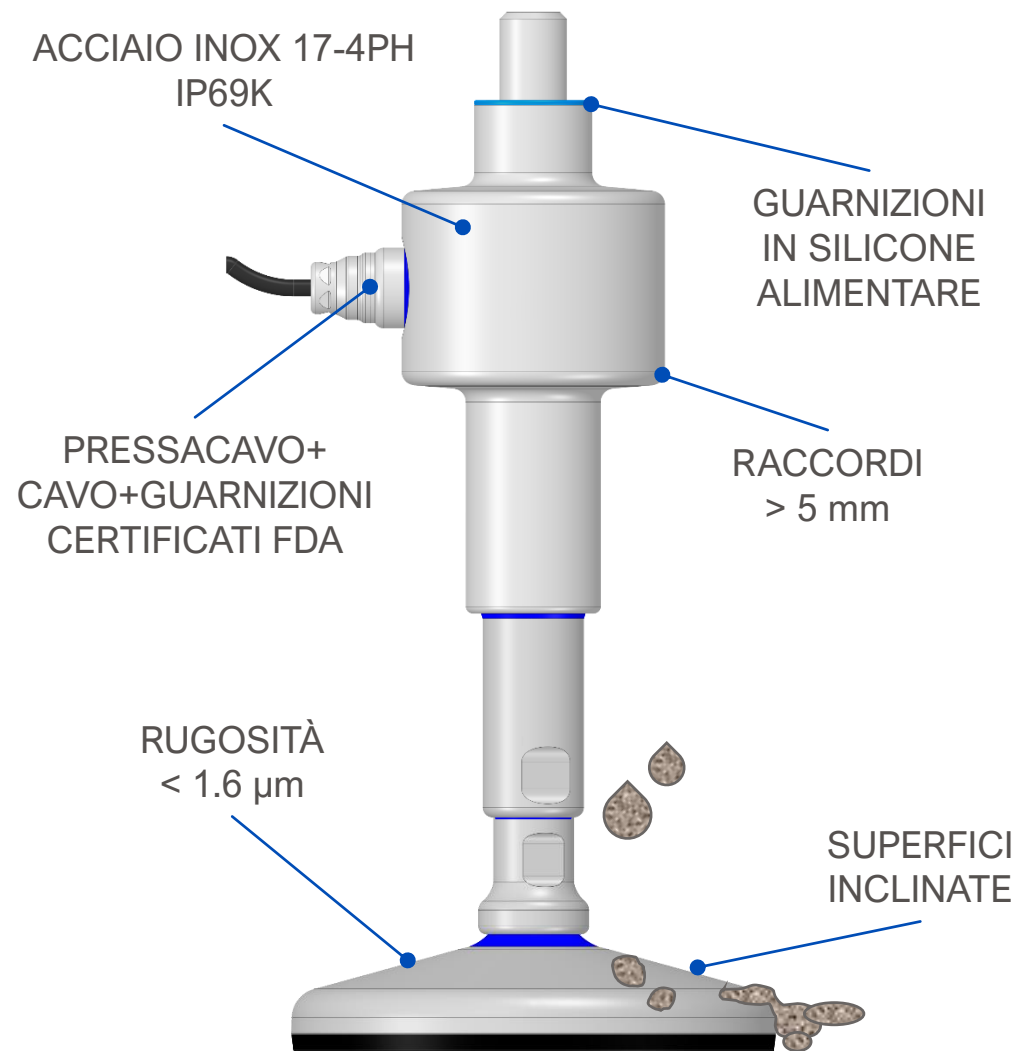

CELLA DI CARICO PER PIEDINO

FLC 3A

Accessorio igienico RPSCQC certificato da 3-A SSI



REQUISITI IGIENICI

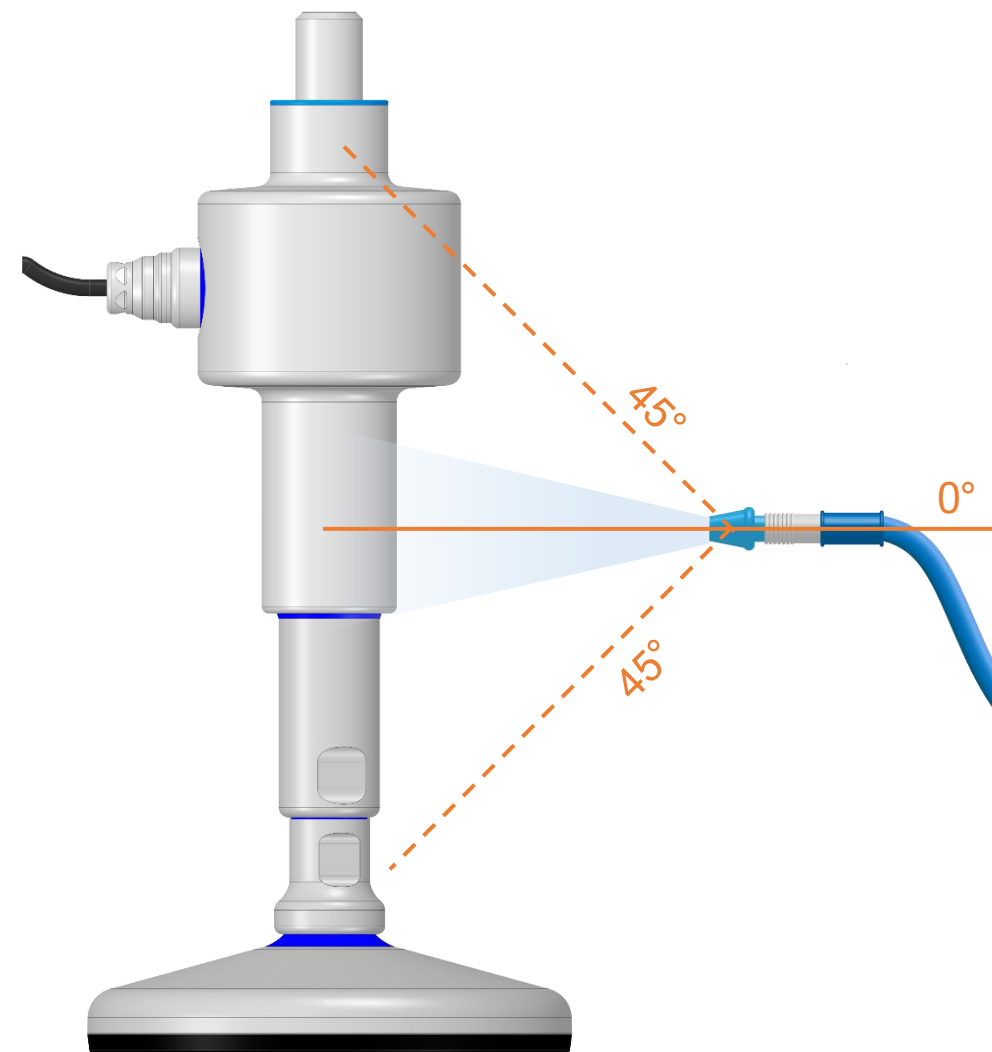

CASSETTA DI GIUNZIONE

CDG 3A

Accessorio igienico RPSCQC certificato da 3-A SSI



CASSETTA DI GIUNZIONE

CDG 3A

Accessorio igienico RPSCQC certificato da 3-A SSI

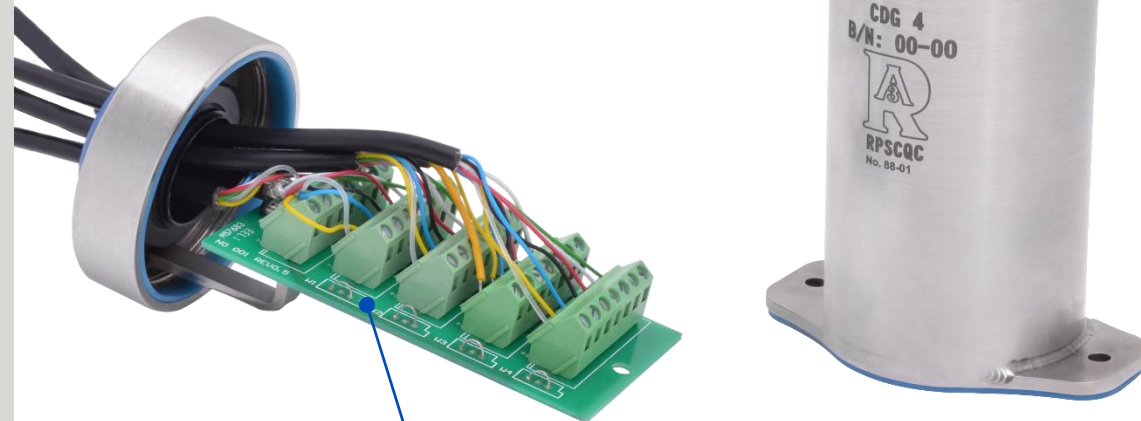

SCHEDA DI EQUALIZZAZIONE
SCHEDA IN PARALLELO

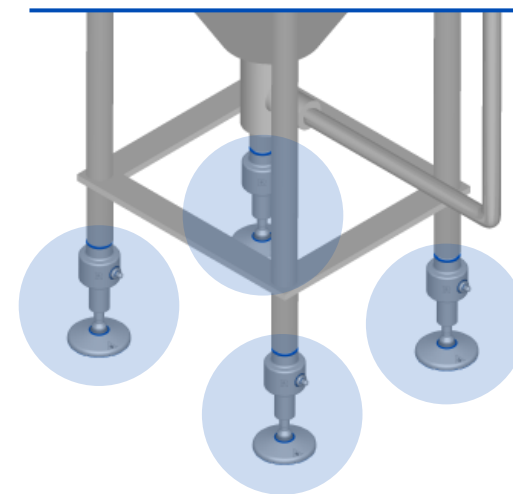

4
CELLE

CASSETTA DI GIUNZIONE

CDG 3A

Accessorio igienico RPSCQC certificato da 3-A SSI



INSTALLAZIONE 3-A

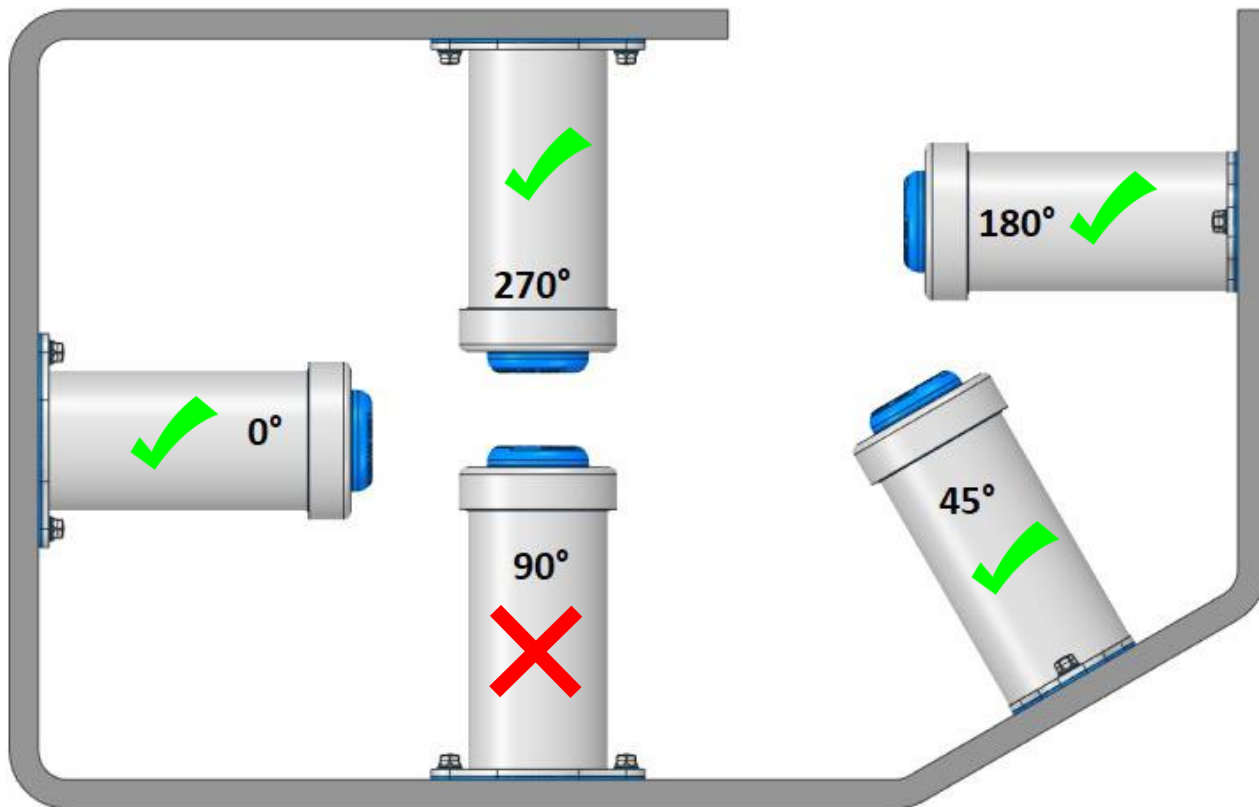

CASSETTA DI GIUNZIONE

CDG 3A

Accessorio igienico RPSCQC certificato da 3-A SSI



REQUISITI IGIENICI



TRASMETTITORE DI PESO INOX

TLM8I 3A

Accessorio igienico RPSCQC certificato da 3-A SSI



TRASMETTITORE DI PESO INOX

TLM81 3A

Accessorio igienico RPSCQC certificato da 3-A SSI



REQUISITI IGIENICI

ACCIAIO INOX 304
IP69K

SUPERFICI SMUSSATE
E INCLINATE

RUGOSITÀ
< 1.6 µm



INSTALLAZIONE
FRONTE QUADRO

GUARNIZIONI
CERTIFICATE
FDA

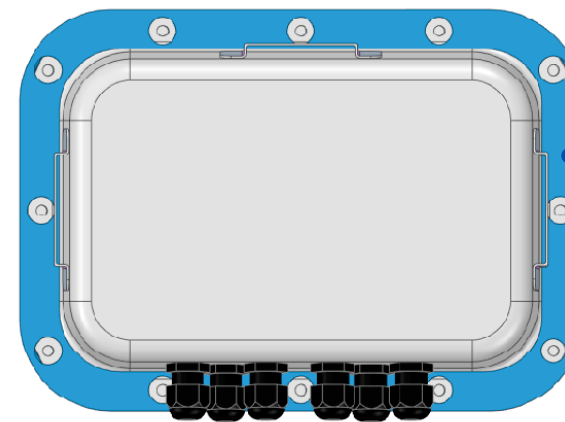

TRASMETTITORE DI PESO INOX

TLM81 3A

Accessorio igienico RPSCQC certificato da 3-A SSI



INSTALLAZIONE NON CERTIFICATA



TRASMETTITORE DI PESO INOX

TLM81 3A

Accessorio igienico RPSCQC certificato da 3-A SSI

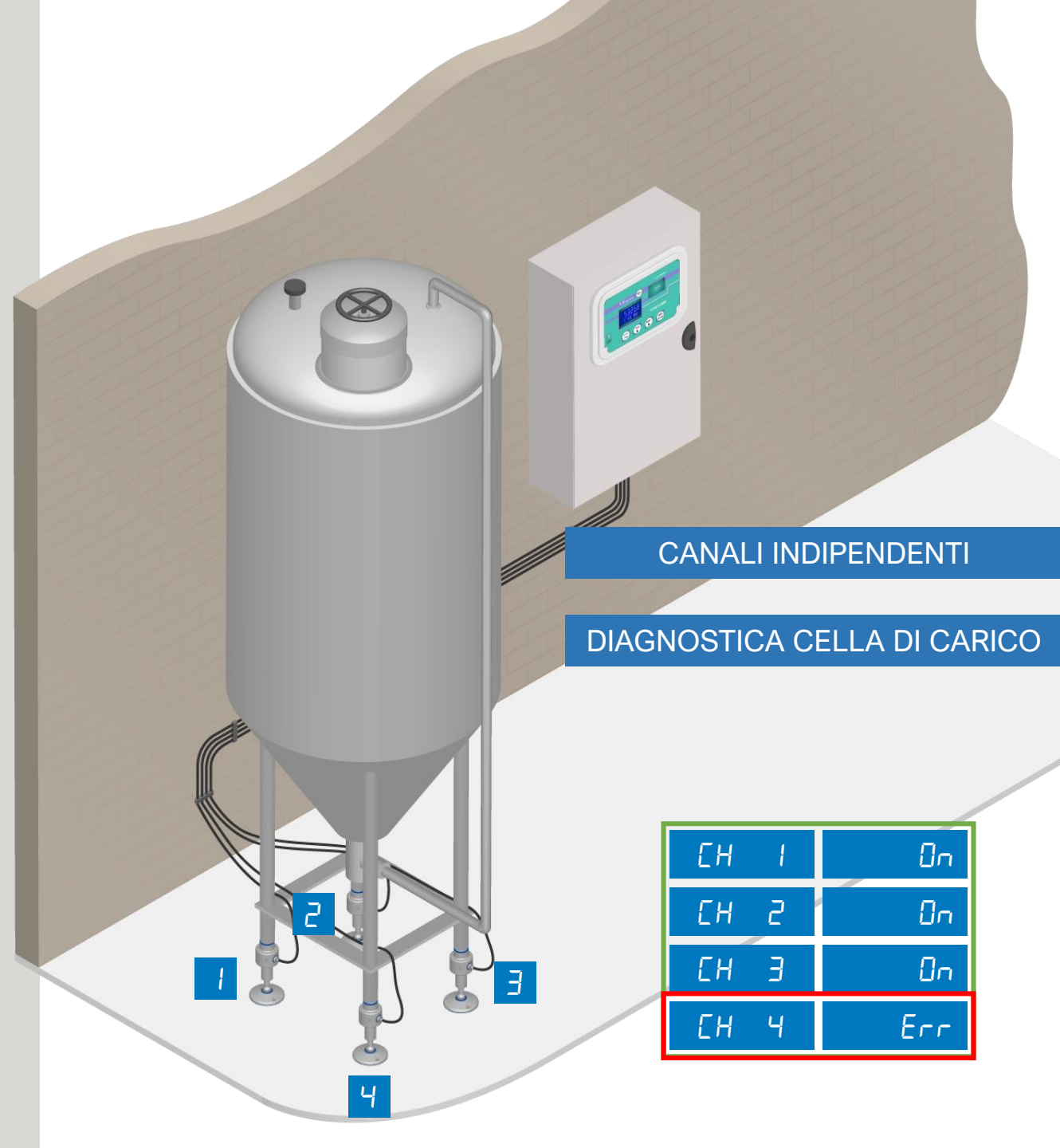

CANALI INDIPENDENTI

DIAGNOSTICA CELLA DI CARICO

CH 1	0n
CH 2	0n
CH 3	0n
CH 4	Err

TRASMETTITORE DI PESO INOX

TLM81 3A

Accessorio igienico RPSCQC certificato da 3-A SSI

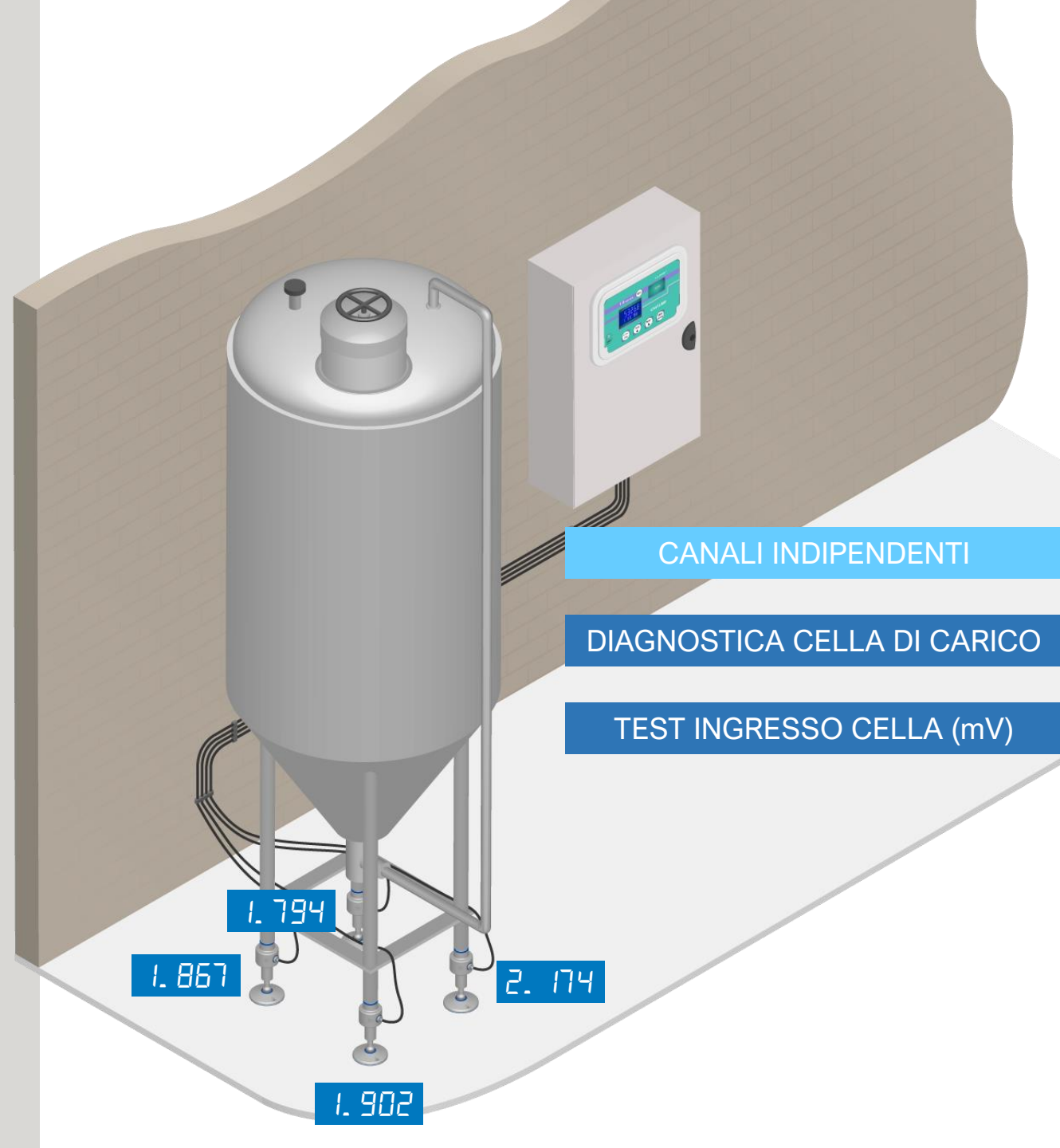

TRASMETTITORE DI PESO INOX

TLM81 3A

Accessorio igienico RPSCQC certificato da 3-A SSI

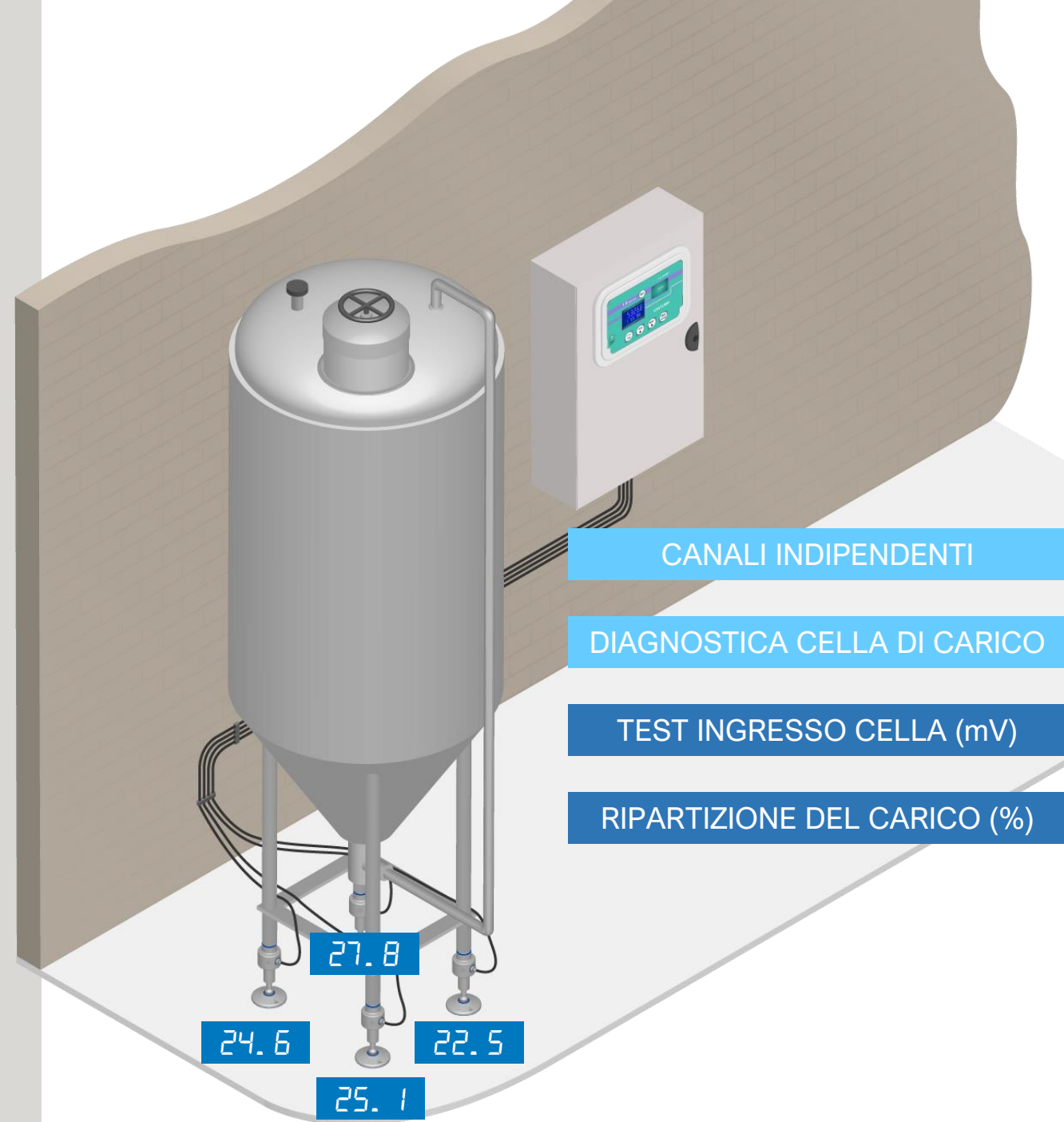

CANALI INDIPENDENTI

DIAGNOSTICA CELLA DI CARICO

TEST INGRESSO CELLA (mV)

RIPARTIZIONE DEL CARICO (%)

TRASMETTITORE DI PESO INOX

TLM81 3A

Accessorio igienico RPSCQC certificato da 3-A SSI

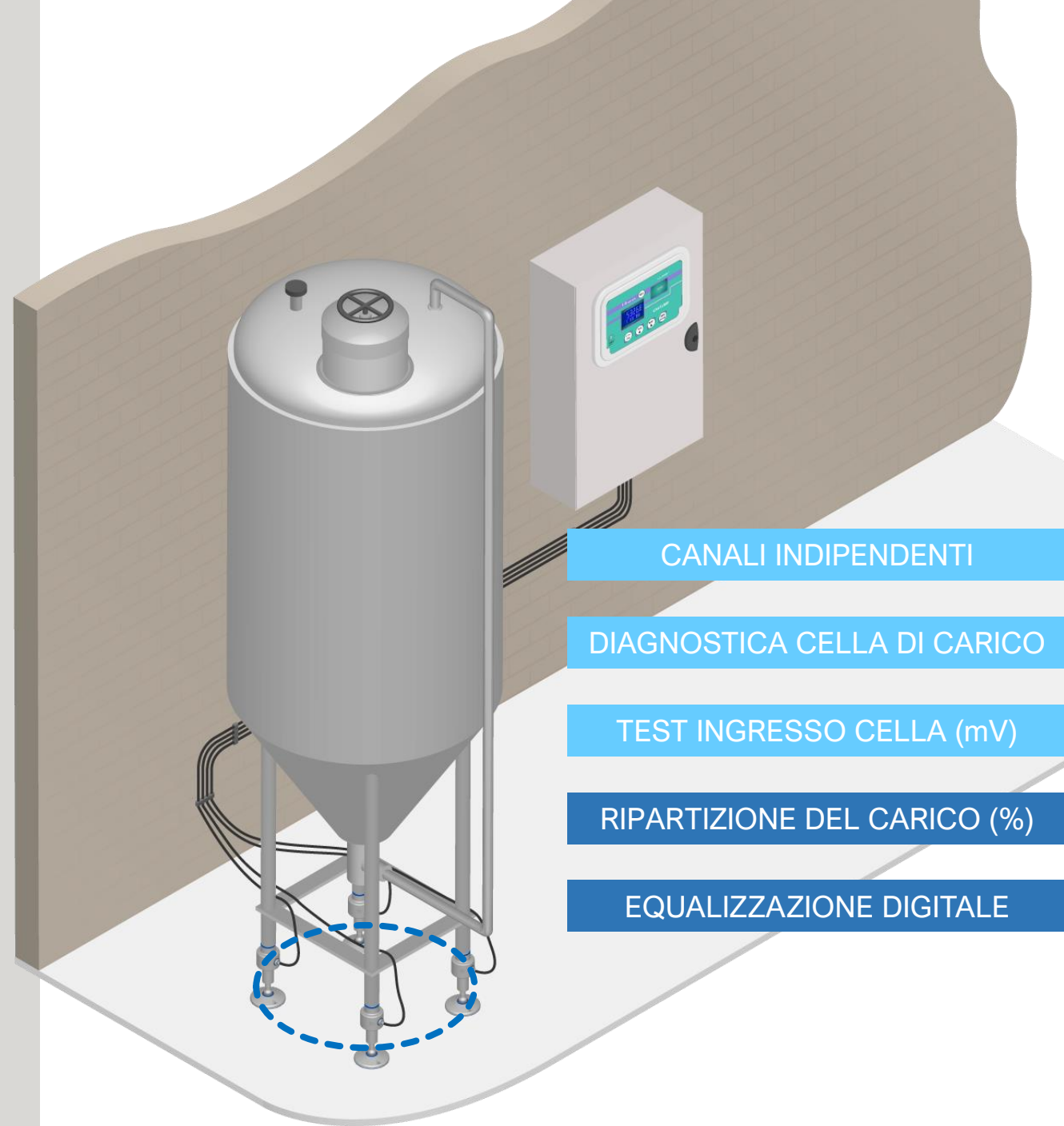

CANALI INDIPENDENTI

DIAGNOSTICA CELLA DI CARICO

TEST INGRESSO CELLA (mV)

RIPARTIZIONE DEL CARICO (%)

EQUALIZZAZIONE DIGITALE

TRASMETTITORE DI PESO INOX

TLM81 3A

Accessorio igienico RPSCQC certificato da 3-A SSI

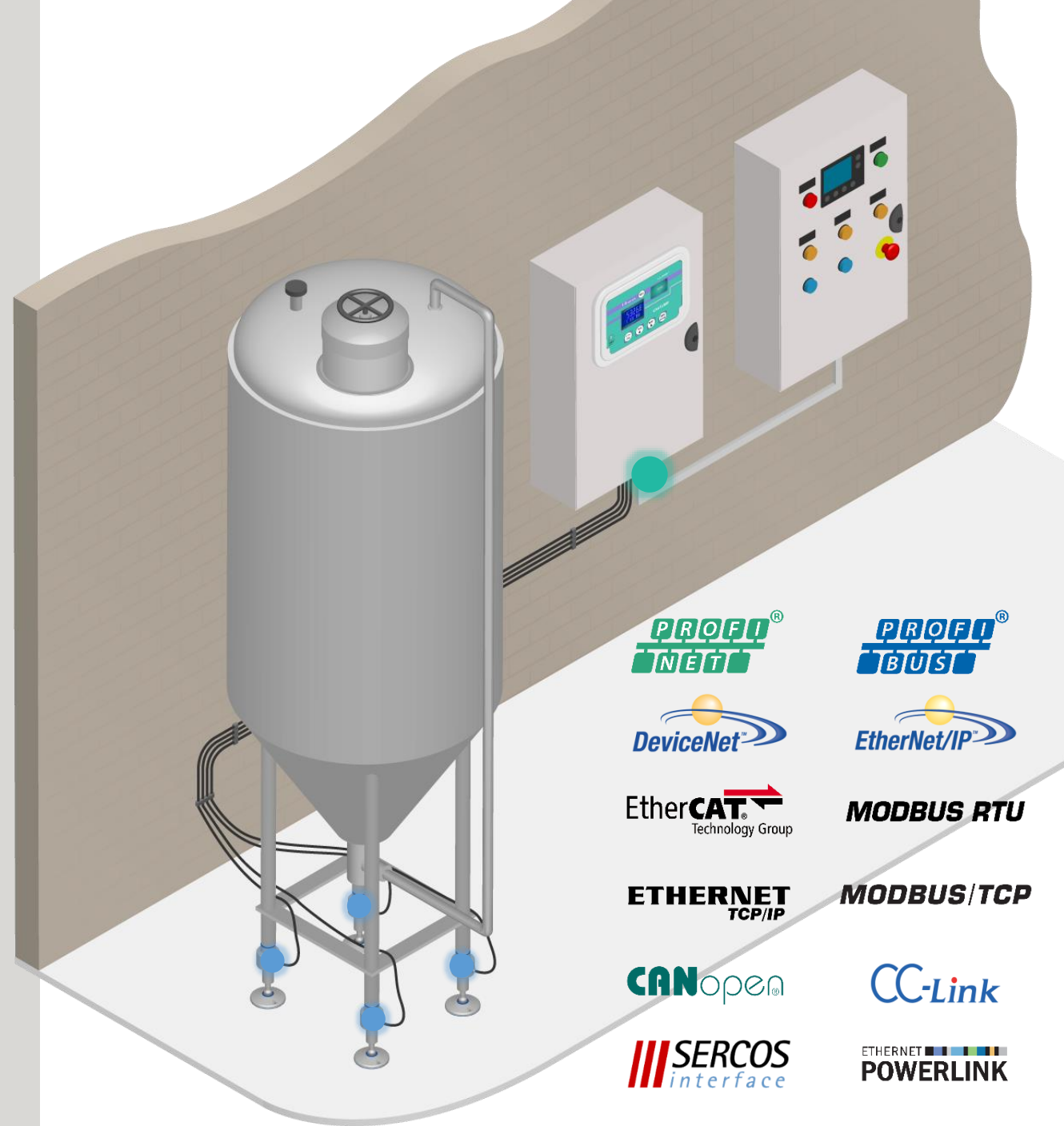

PROFI[®]
NET

PROFI[®]
BUS

DeviceNet

EtherNet/IP

EtherCAT[®]
Technology Group

MODBUS RTU

ETHERNET
TCP/IP

MODBUS/TCP

CANopen

CC-Link

SERCOS
interface

ETHERNET
POWERLINK

TRASMETTITORE DI PESO INOX

TLM81 3A

Accessorio igienico RPSCQC certificato da 3-A SSI

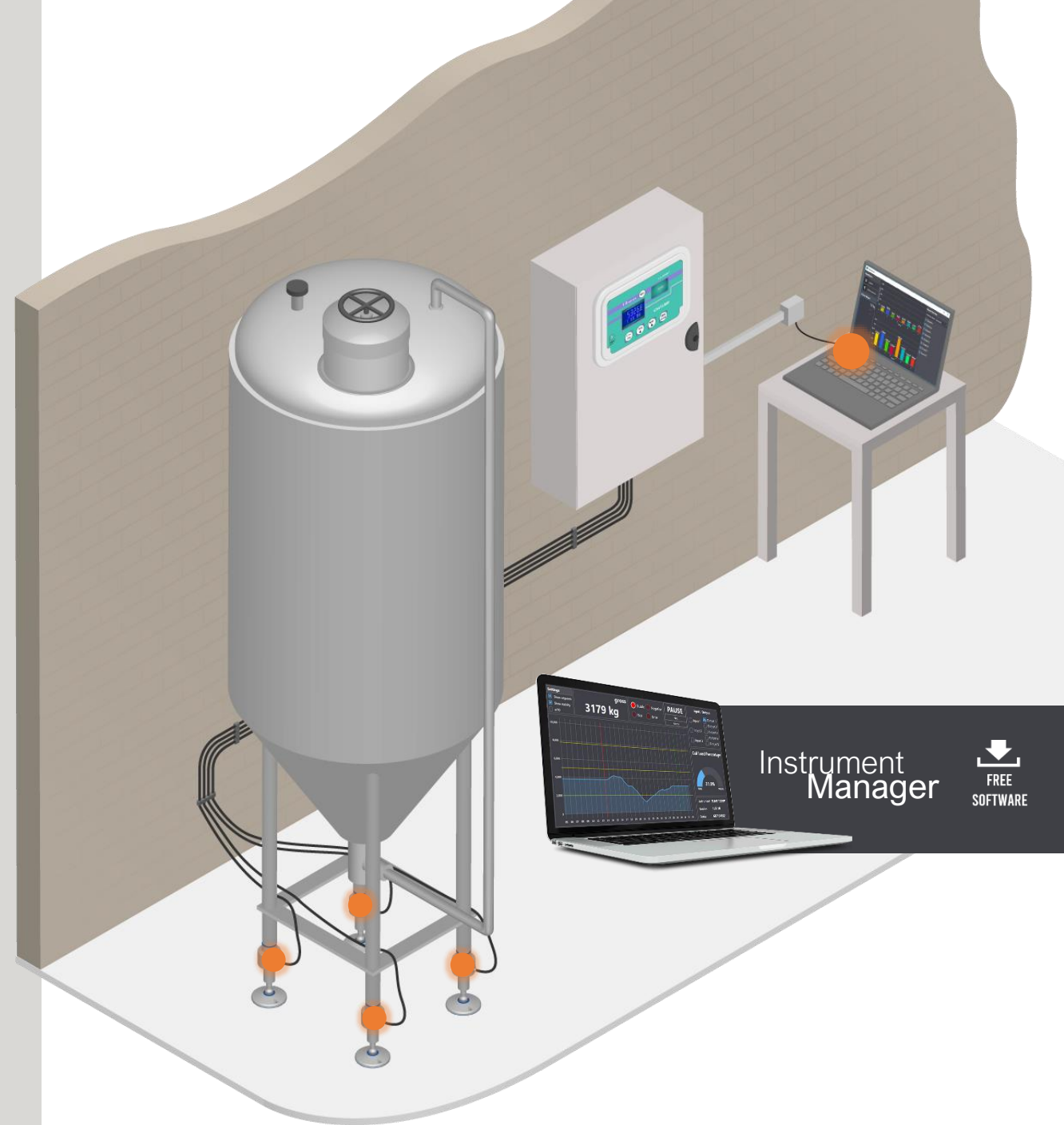

Instrument
Manager

FREE
SOFTWARE

INDICATORE DI PESO – VERSIONE IGIENICA

WINOX 3A

Accessorio igienico RPSCQC certificato da 3-A SSI



INDICATORE DI PESO – VERSIONE IGIENICA

WINOX 3A

Accessorio igienico RPSCQC certificato da 3-A SSI



REQUISITI IGIENICI

ACCIAIO INOX 304
IP69K

SUPERFICI SMUSSATE
E INCLINATE

RUGOSITÀ
< 1.6 µm

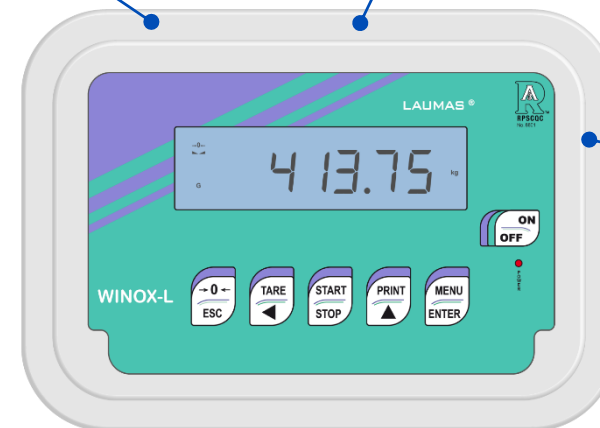

INSTALLAZIONE
FRONTE QUADRO

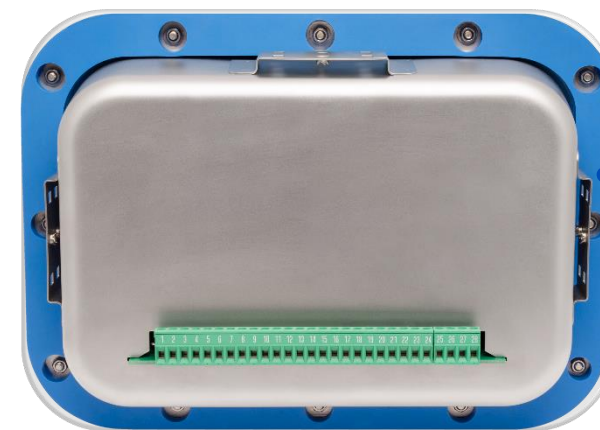

GUARNIZIONI
CERTIFICATE
FDA

INDICATORE DI PESO – VERSIONE IGIENICA

WINOX 3A

Accessorio igienico RPSCQC certificato da 3-A SSI

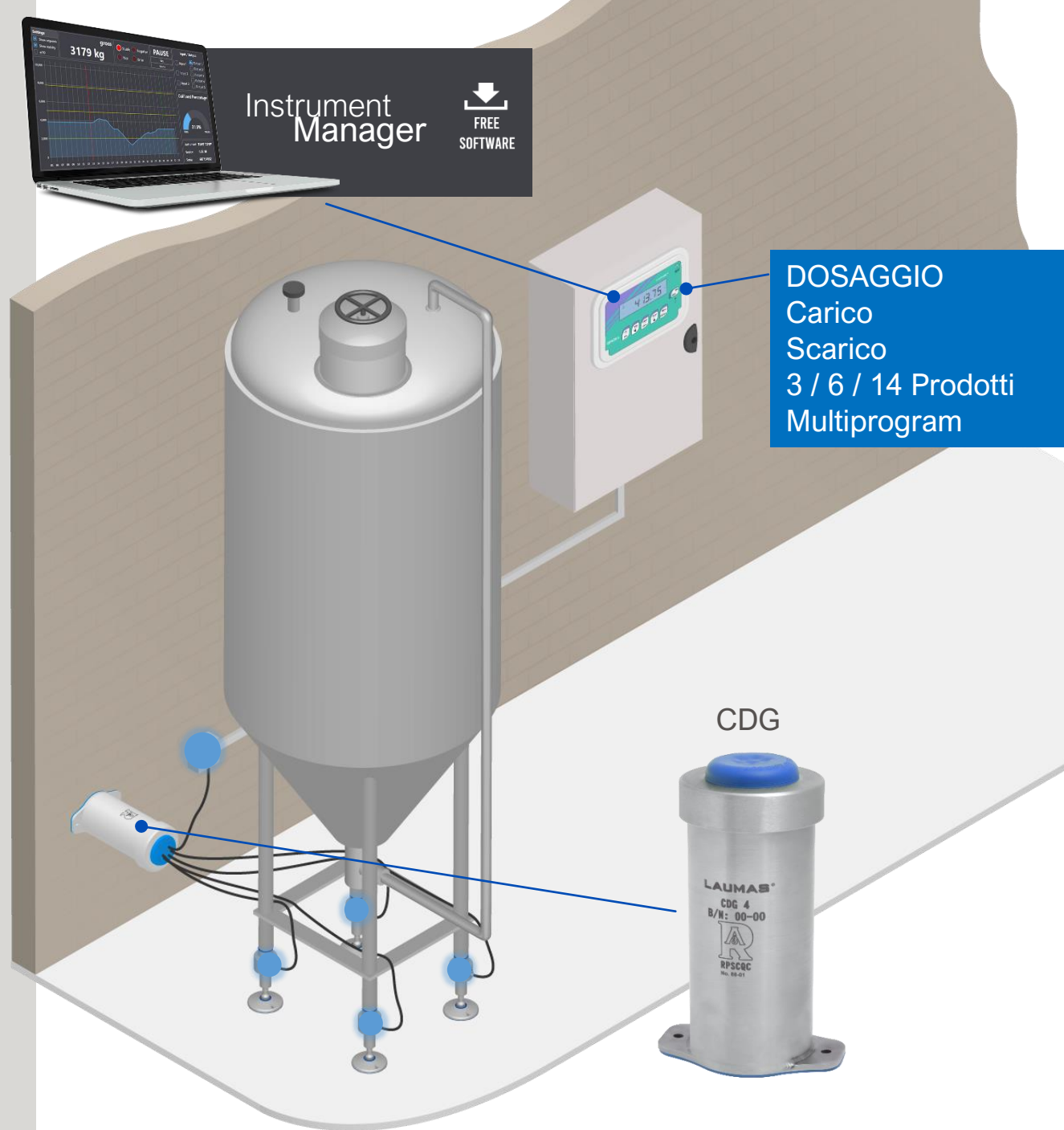

DOSAGGIO
Carico
Scarico
3 / 6 / 14 Prodotti
Multiprogram

CDG



INDICATORE DI PESO – VERSIONE IGIENICA

WINOX 3A

Accessorio igienico RPSCQC certificato da 3-A SSI

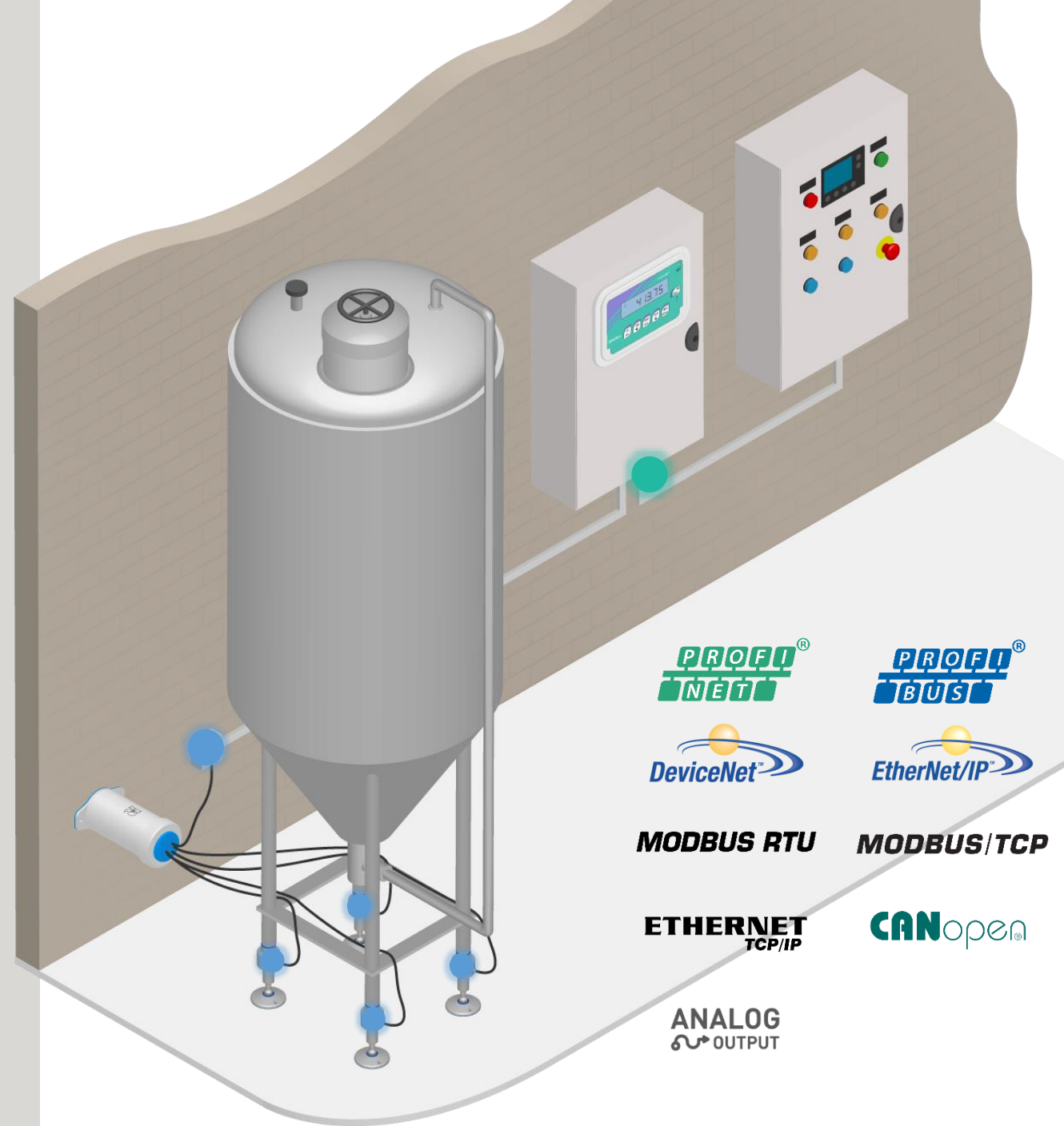

PROFI[®]
NET

PROFI[®]
BUS

DeviceNet[™]

EtherNet/IP[™]

MODBUS RTU

MODBUS/TCP

ETHERNET
TCP/IP

CANopen[®]

ANALOG
OUTPUT

DIGITALIZZATORE UNIVERSALE – VERSIONE IGIENICA

LCB 3A

Accessorio igienico RPSCQC certificato da 3-A SSI



DIGITALIZZATORE UNIVERSALE – VERSIONE IGIENICA

LCB 3A

Accessorio igienico RPSCQC certificato da 3-A SSI



REQUISITI IGIENICI

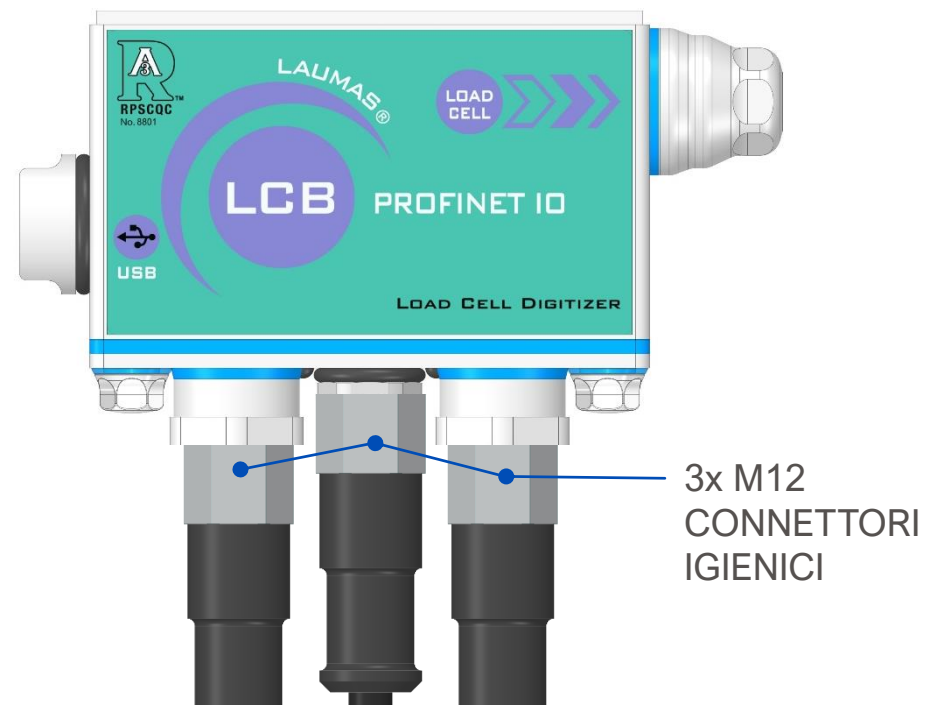
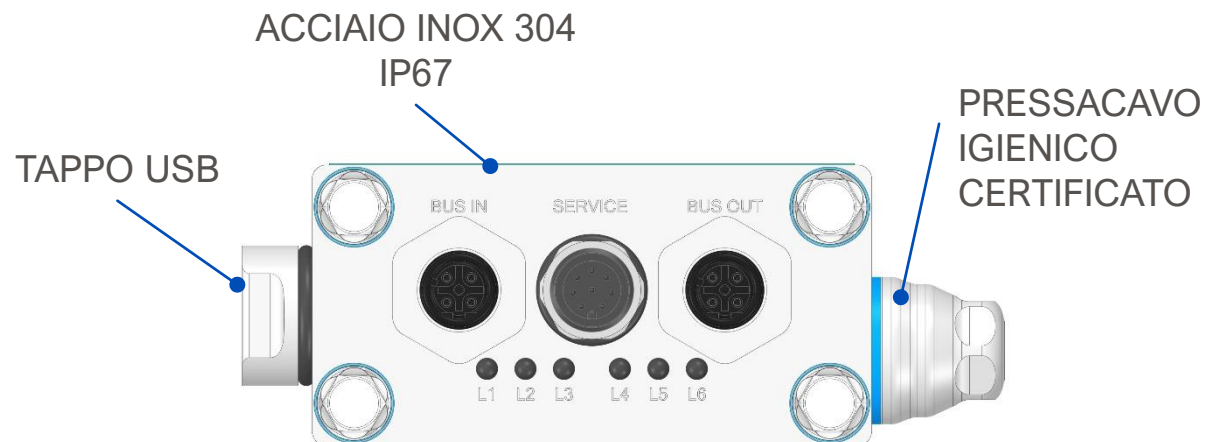

DIGITALIZZATORE UNIVERSALE – VERSIONE IGIENICA

LCB 3A

Accessorio igienico RPSCQC certificato da 3-A SSI

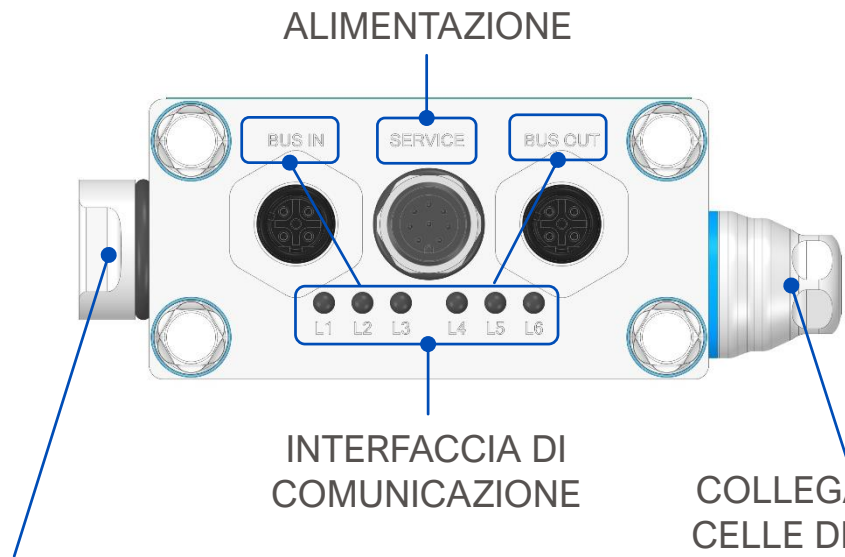

MICRO USB PER LA CONFIGURAZIONE DA PC

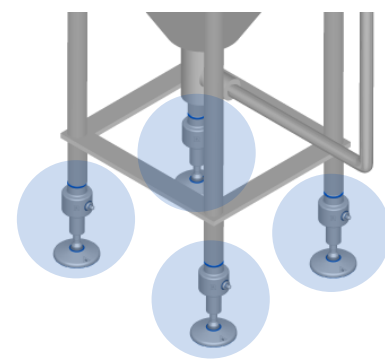

DIGITALIZZATORE UNIVERSALE – VERSIONE IGIENICA

LCB 3A

Accessorio igienico RPSCQC certificato da 3-A SSI



COLLEGAMENTO IGIENICO
TRAMITE CAVO

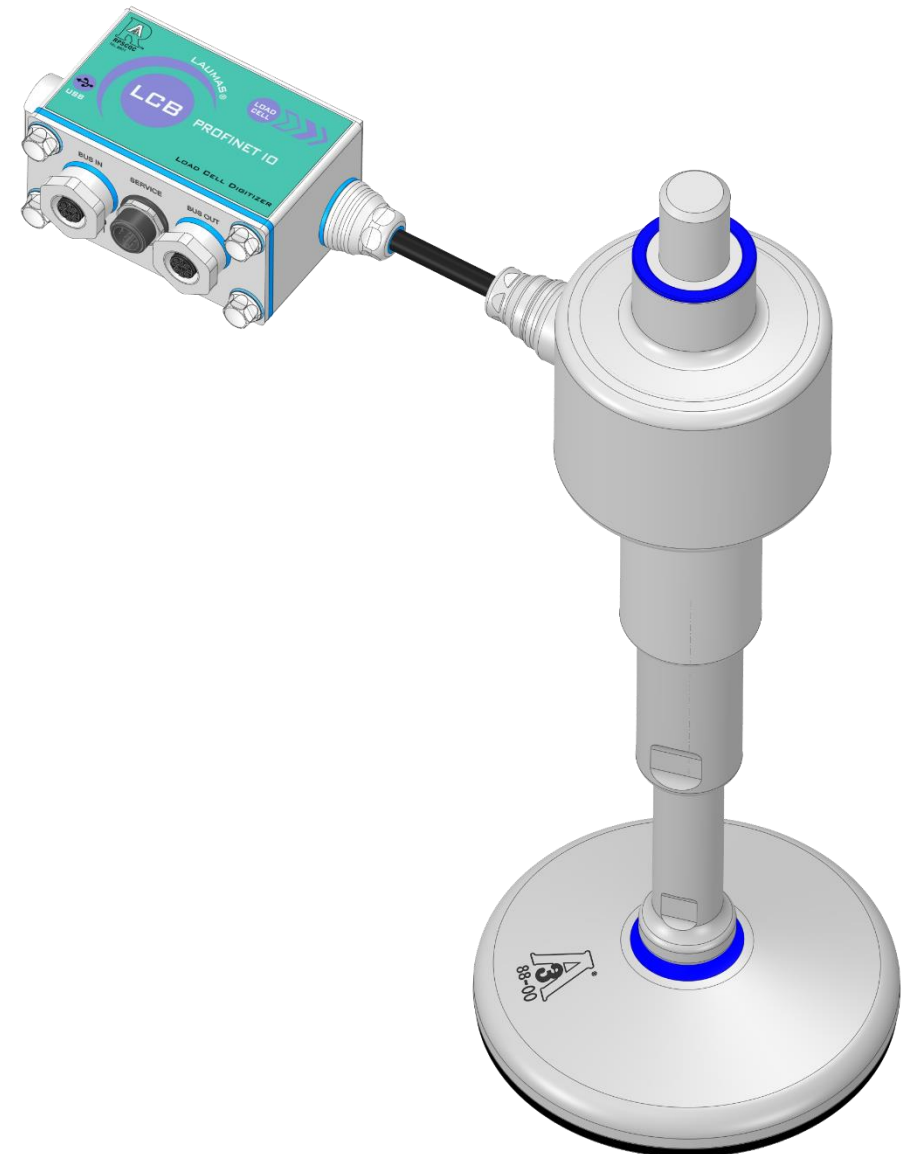

DIGITALIZZATORE UNIVERSALE – VERSIONE IGIENICA

LCB 3A

Accessorio igienico RPSCQC certificato da 3-A SSI



COLLEGAMENTO IGIENICO
TRAMITE CAVO

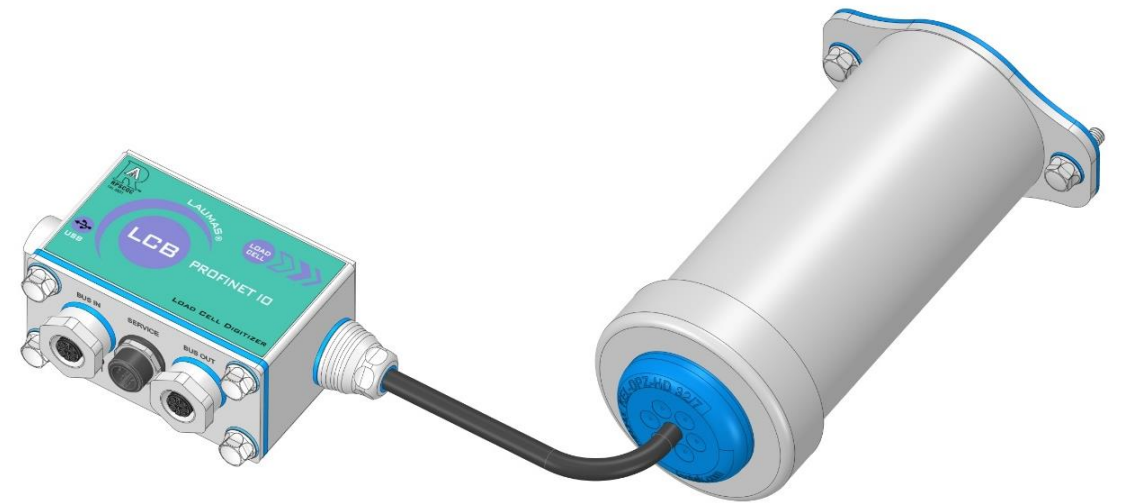

DIGITALIZZATORE UNIVERSALE – VERSIONE IGIENICA

LCB 3A

Accessorio igienico RPSCQC certificato da 3-A SSI



COLLEGAMENTO IGIENICO
TRAMITE ADATTATORE

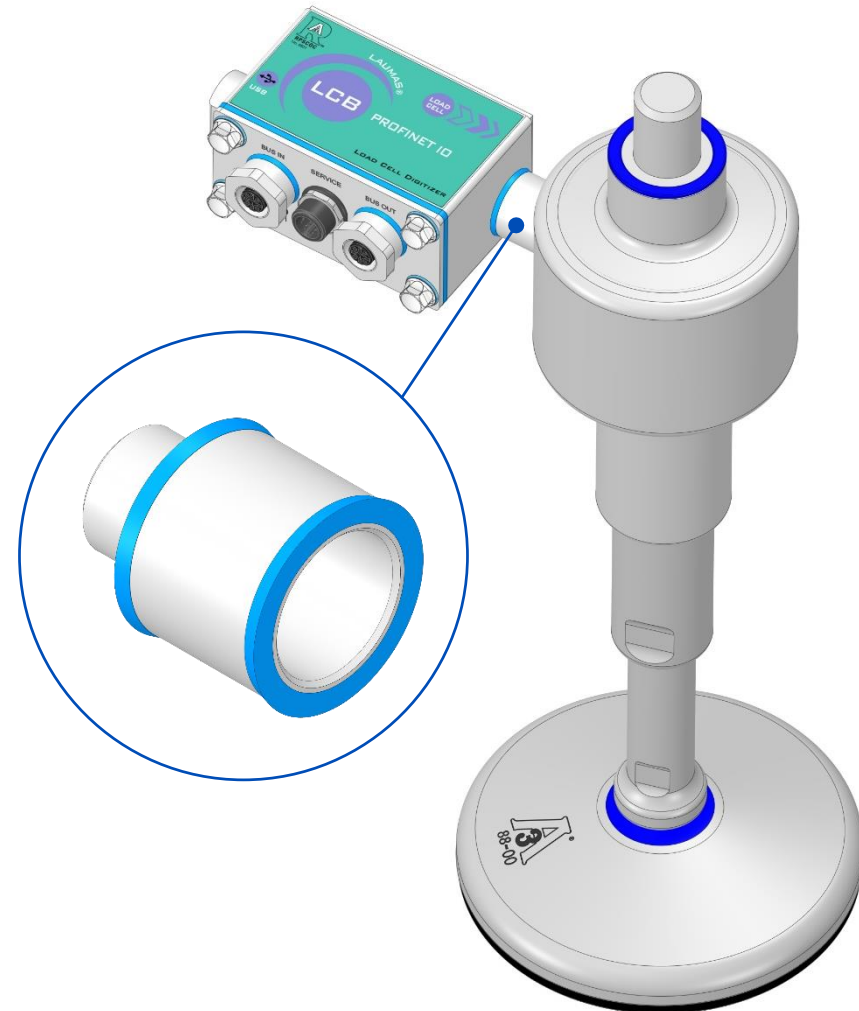

DIGITALIZZATORE UNIVERSALE – VERSIONE IGIENICA

LCB 3A

Accessorio igienico RPSCQC certificato da 3-A SSI



COLLEGAMENTO IN SERIE

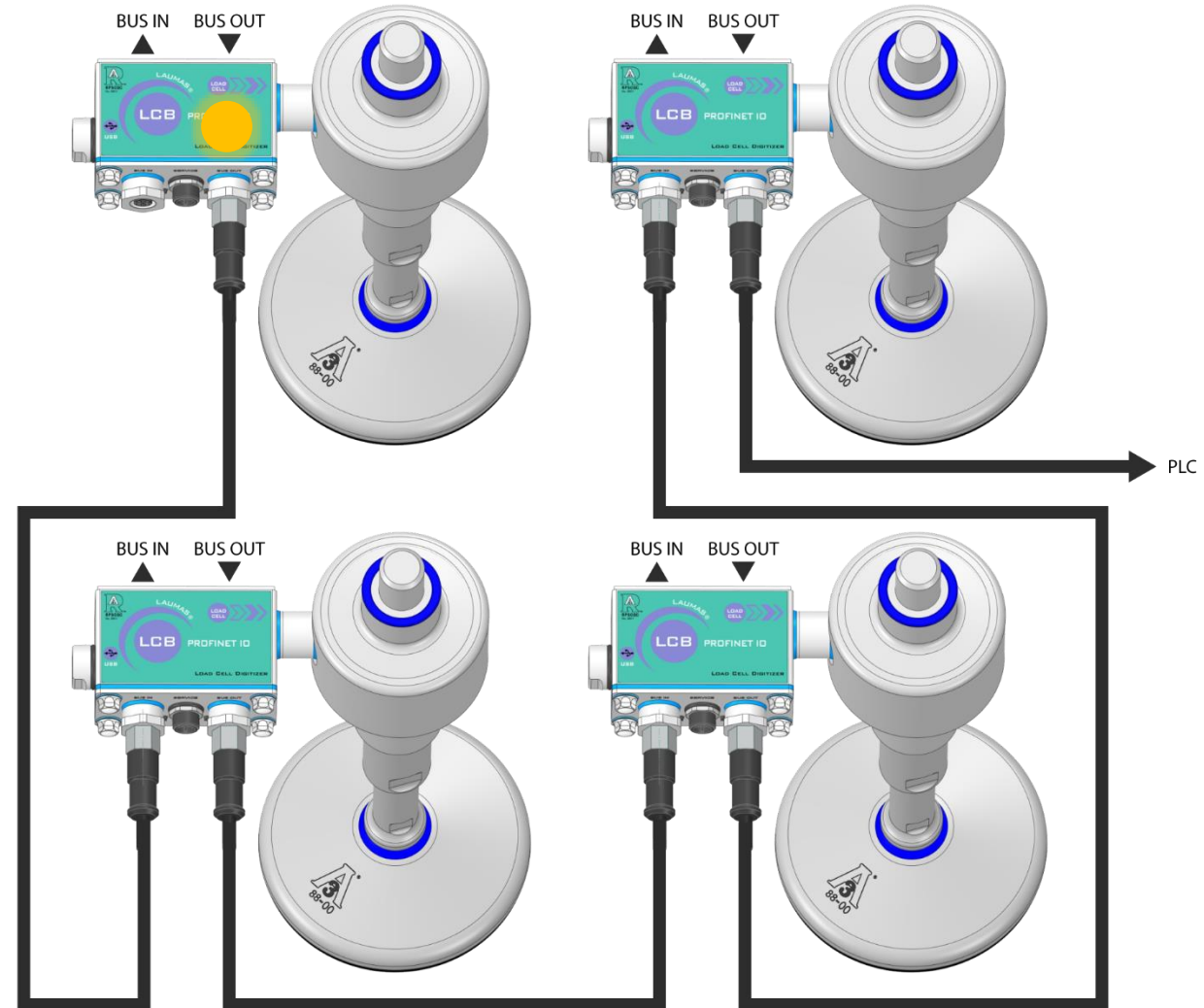

DIGITALIZZATORE UNIVERSALE – VERSIONE IGIENICA

LCB 3A

Accessorio igienico RPSCQC certificato da 3-A SSI



PROFINET

PROFIBUS

EtherCAT
Technology Group

EtherNet/IP

MODBUS RTU

MODBUS/TCP

ETHERNET
TCP/IP

CANopen

CC-Link

CC-Link IE

SERCOS
interface

ETHERNET
POWERLINK

IO-Link

ANALOG
OUTPUT

www.laumas.com/it



sales@laumas.it

Scrivici per richiedere
**l'attestato di partecipazione o
ulteriori informazioni**



[Webinar & Tutorials](#)

L'archivio dei **Webinar** e
dei video **Tutorial** per una
formazione completa

#LAUMASKnowHow



[Calendario Webinar](#)

Consulta il programma
dei prossimi corsi online e
scegli quello che fa per te

Grazie per l'attenzione!