

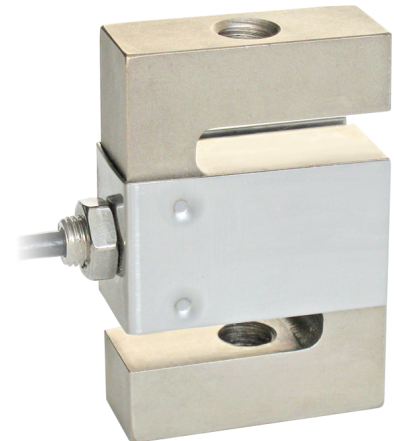

Capacity from 25 kg to 2500 kg

- AISI 4340 NICKEL PLATED STEEL
- COMBINED ERROR $\leq \pm 0.02\%$ (0.017% C4)
- IP67 PROTECTION RATING



CAPACITY	kg	ACCURACY CLASS			NET WEIGHT (kg)
		C3	C4		
25		–	–	–	0.4
100		•	•	•	0.6
200		•	•	–	0.6
300		•	•	–	0.6
500		•	•	•	0.7
1000		•	•	•	0.9
2500		•	•	•	1.6

ON REQUEST

CERTIFICATIONS

- OIML R60 C3
- Complies with the Eurasian Customs Union regulations
- Equivalent of the CE marking for the United Kingdom

CERTIFICATIONS ON REQUEST

	Calibration report
	LAT Accredia calibration certificate ISO 376 or ASTM E74 for capacities from 1000 kg to 10000 kg
	ATEX (zone 2-22)
	ATEX/IECEx (zone 1-21)
	OIML R60 C4
	Complies with the Eurasian Customs Union regulations for use in potentially explosive atmospheres
	FM HazLoc - Complies with the United States and Canada regulations for use in potentially explosive atmospheres
	Complies with Chinese market regulations for use in potentially explosive atmospheres
	NTEP - Complies with United States regulations for legal for trade use

COMPLEMENTARY ACCESSORIES

	DESCRIPTION	DIMENSIONS	LOAD CELL CAPACITY	CODE
	Ball-and-socket joint with nut:			
	stainless steel	M12x1.75	200-1000 kg	EM-INOX
		M20x1.5	2500 kg	
	galvanized C40 steel	M8x1.25	25 kg	EM
		M10x1.5	100 kg	
		M12x1.75	200-1000 kg	
M20x1.5		2500 kg		

DIMENSIONS (mm)

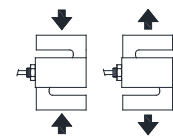
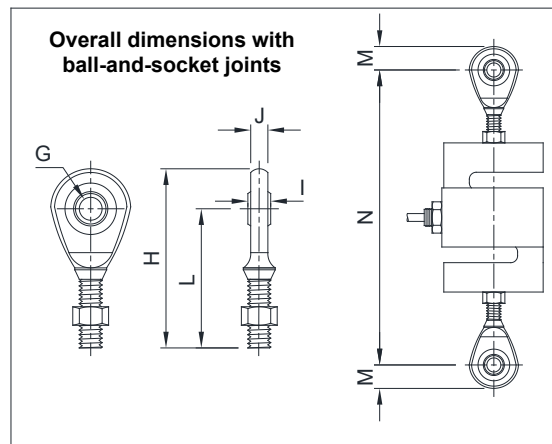
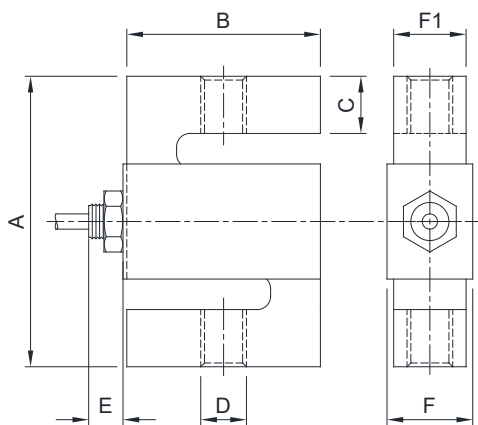

Example of application on the tension bar mechanical scale

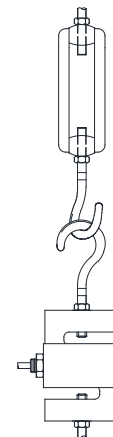

	A	B	C	D	E	F	F1	G	H	I	J	L	M	N (≈)
25 kg	76.2	50.8	15.7	M8x1.25	10	14.5	12.7	Ø8	54	8	6.5	42.5	11.5	129
100 kg	76.2	50.8	15.3	M10x1.5	9	22.4	19	Ø10	62.5	9	7.5	48.5	14	142
200 kg					8									
300 kg	76.2	50.8	14.4	M12x1.75	9	22.4	19	Ø12	71	10	8.5	54.5	16.5	154
500 kg					9									
1000 kg	76.2	50.8	12.5	M12x1.75	10	28.9	25.4	Ø12	71	10	8.5	54.5	16.5	159
2500 kg	101.6	76.2	20	M20x1.5	6	28.9	25.4	Ø20	104.5	16	13.5	77.5	27	217

TECHNICAL FEATURES

Material	AISI 4340 nickel plated steel		
OIML R60 Accuracy class • Verification intervals	-	C3 • 3000	C4 • 4000
Nominal load (E max)	25 kg	100 - 200 - 300 kg 500 - 1000 - 2500 kg	100 - 200 - 300 kg 500 - 1000 - 2500 kg
Minimum verification interval (V min)	-	E max / 10000 E max / 15000	E max / 20000
Combined error	≤ ±0.02%	≤ ±0.02%	≤ ±0.017%
Protection rating	IP67		
Rated output	2 mV/V ±0.2%	Input resistance	350 Ω ±3.5
Temperature effect on zero	0.0015% °C	Output resistance	350 Ω ±3.5
Temperature effect on span	0.0017% °C	Zero balance	±1%
Compensated temperature range	-10 °C / +40 °C	Insulation resistance	>5000 MΩ
Operating temperature range	-35 °C / +65 °C	Safe overload (% of full scale)	150%
Creep at nominal load in 30 minutes	0.03%	Ultimate overload (% of full scale)	300%
Max supply voltage without damage	18 V	Deflection at nominal load	0.4 mm

ELECTRICAL CONNECTIONS

Cable length	5 m (25 - 300 kg); 10 m (500 - 2500 kg)
Cable diameter	5 mm
Cores	4 x 0.24 mm ²

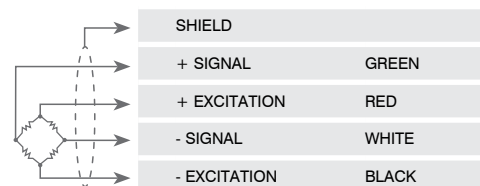

The Company reserves the right to make changes to the technical data, drawings and images without notice.